



AVIATION

GRADE 10

COMPETENCY BASED CURRICULUM

“
The sky is not
the limit, it is
only the beginning.”



PILOT SKILLS



AIRPORT
OPERATIONS



AIR TRAFFIC
MANAGEMENT



LEARN
Build knowledge
and understanding



PRACTICE
Apply skills
in real life



SUCCEED
Become competent
and confident



CAREER READY
Prepare for
aviation careers



CBCKENYAHUB.COM

YOUR TRUSTED CBC RESOURCE
FOR **QUALITY LEARNING**

SUMMARY OF STRANDS AND SUB STRANDS

Strands Sub Strands Suggested Number of Lessons

1.0 FOUNDATIONS OF AVIATION TECHNOLOGY

1.1 Introduction to Aviation Technology 10

1.2 Safety in the Aviation Workplace 15

1.3 Airport Safety 20

2.0 AIRCRAFT BASIC CONSTRUCTION

2.1 Aircraft Components 10

2.2 Aircraft Tools and Materials 20

2.3 Aircraft Related Drawing: Isometric Drawing 20

3.0 FLIGHT OPERATIONS

3.1 Aviation Weather 15

3.2 Aviation Communication 15

3.3 Aerodynamics of Flight 15

4.0 AIRPORT OPERATIONS

4.1 The Airport 20

4.2 Airport Business Services 20

1.0 FOUNDATIONS OF AVIATION TECHNOLOGY

Strand 1.0: Foundations of Aviation Technology

Sub-Strand 1.1: Introduction to Aviation Technology (10 lessons)

1. Historical Milestones in the Development of Aircraft

Aviation technology has evolved through significant milestones.

❖ **Hot Air Balloons:**

- ✚ Early attempts at flight using heated air.



- ✚ Montgolfier brothers' first successful hot air balloon flight in 1783.

❖ **Gliders:**

- ✚ Unpowered aircraft that rely on air currents for lift.



- ✚ Sir George Cayley's pioneering glider designs in the 19th century.

❖ **Fixed-Wing Aircraft:**

FOR MORE RESOURCES cbckenyahub.com

- ✚ Powered aircraft with rigid wings.



- ✚ flight in 1903.

Wright brothers' first successful powered, sustained, and controlled

- ❖ **Rotary-Wing Aircraft (Helicopters):**



Aircraft that use rotating blades for lift and propulsion.



century.
helicopters in the 20th

Igor Sikorsky's development of practical

- ❖ **Jet Aircraft:**



Aircraft powered by jet engines, allowing for much faster flight.

❖ **Modern Aviation:**



Advances in materials, electronics, and aerodynamics have led to highly efficient and sophisticated aircraft.

2. Contribution of Key Pioneers to the Development of Aircraft

✚ Key individuals have made significant contributions to aviation.

✓ **Montgolfier Brothers (Joseph-Michel and Jacques-Étienne Montgolfier):**



- ❖ Pioneered hot air balloon flight.
- ❖ Demonstrated the principle of buoyancy. ✓ **Sir George Cayley:**



- ❖ Considered the "father of aviation."

- ❖ Developed the concept of a fixed-wing aircraft with separate lift, propulsion, and control systems.

✓ **Wright Brothers (Orville and Wilbur Wright):**



- ❖ Achieved the first sustained, controlled, powered flight.
- ❖ Developed the three-axis control system. ✓ **Igor Sikorsky:**



- ❖ Pioneered the development of practical helicopters. ❖
Designed and built successful helicopters.

3. Categories of the Types of Aircraft in Aviation.

□ Aircraft can be categorized based on their design and operation.

✦ **Lighter-Than-Air Aircraft:**



- ✓ Aircraft that achieve lift through buoyancy.
- ✓ Examples: Hot air balloons, airships (zeppelins).



- *Balloons*

Balloons are one of the simplest forms of lighter-than-air aircraft. They come in two main types: **hot air balloons**, which use heated air to gain lift, and **gas balloons**, which use lighter-than-air gases like helium or hydrogen. Balloons are primarily used for recreational purposes, such as sightseeing and competitive ballooning events.

- *Airships*

Airships, or dirigibles, are more complex than balloons and are equipped with engines and steering capabilities, allowing for controlled flight. They have been historically significant in transportation and reconnaissance. Today, airships are often used for advertising, tourism, and aerial photography.

- *Tethered Aerostats*

Tethered aerostats are balloons or airships that are anchored to the ground. They are used for various purposes, including surveillance and research, as they can remain fixed for extended periods.

- ✦ **Heavier-Than-Air Aircraft:**



✓ Aircraft that generate lift through aerodynamic forces.

- ✓ Examples: Fixed-wing aircraft (airplanes), rotary-wing aircraft (helicopters).

✚ **Fixed Wing Aircraft further categorization:**



- ✓ Commercial airliners.
- ✓ Cargo aircraft.
- ✓ General aviation aircraft (small planes).
- ✓ Military aircraft (fighters, bombers, etc.).

✚ **Rotary Wing Aircraft further categorization:**



- ✓ Helicopters. ✓ Autogyros.

4. Demonstrate Heavier and Lighter-Than-Air Aircraft in Aviation.

□ Practical demonstrations can enhance understanding.

✓ **Lighter-Than-Air Demonstration:**

- Inflate a balloon with heated air to show buoyancy.

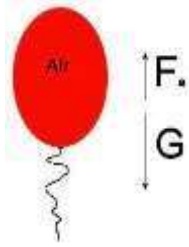

✓ **Heavier-Than-Air Demonstration:**

- Construct and fly a kite or hand glider to demonstrate lift.



- Use paper airplanes to show the principals of flight.

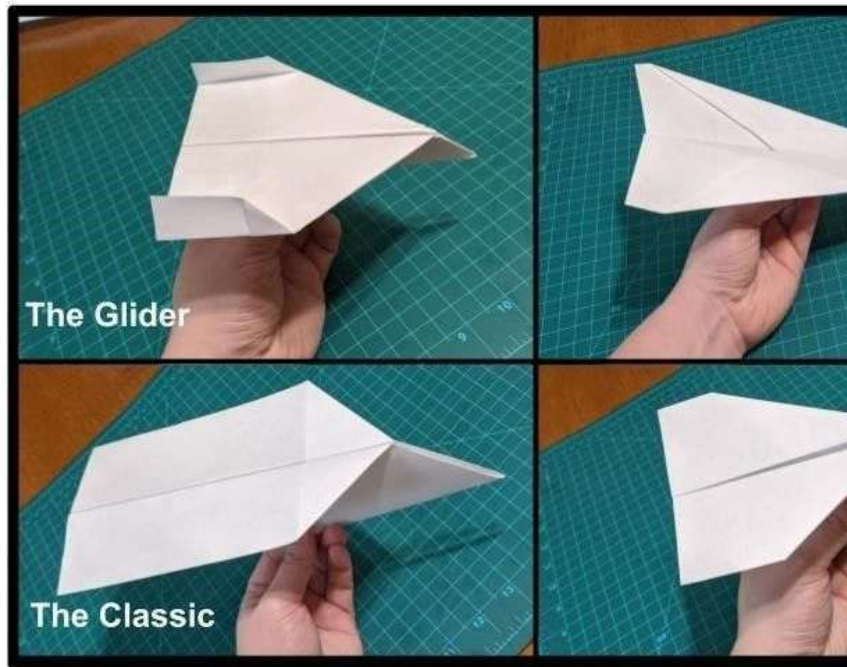

5. Functions of Different Types of Aircraft in Aviation (Learning Outcome e):

□ Different aircraft serve various functions. ✓

Commercial Airliners:



FOR MORE RESOURCES cbckenyahub.com

- Transport passengers over long distances. ✓ **Cargo Aircraft:**



- Transport goods and freight. ✓ **General Aviation Aircraft:**



- Used for private flights, training, and recreational activities.

✓ **Military Aircraft:**



- Used for defense, reconnaissance, and combat.

✓ **Helicopters:**



- Used for search and rescue, medical evacuations, and transportation to remote areas.

6. Appreciate the Milestones of Aircraft Development in the Aviation Industry (

- Recognizing the historical progression of aviation fosters appreciation for its advancements.
- ✓ The progression from early balloons to modern jetliners represents a significant technological achievement.
- ✓ Aviation has transformed transportation, communication, and global connectivity.

Suggested Learning Experiences:

- ✓ **Internet Research:** Use digital devices to watch video clips on aviation history.
- ✓ **Chart Creation:** Showcase historical milestones visually.
- ✓ **Discussions:** Discuss the contributions of key pioneers.
- ✓ **Visual Aids:** Use visual aids and digital devices to explore different types of aircraft.
- ✓ **Checklist Development:** Create a checklist of aircraft types.
- ✓ **Practical Demonstrations:** Construct and demonstrate lighter and heavier-than-air aircraft.
- ✓ **Brainstorming:** Discuss the functions of various aircraft.
- ✓ **Aerodrome Tour:** Observe different aircraft types at a local aerodrome.

Important Notes for Teachers:

- ✓ Emphasize the practical applications of aviation principles.
- ✓ Use visual aids and hands-on activities to enhance learning.
- ✓ Encourage learners to research and present on aviation history.
- ✓ Ensure safety during practical demonstrations and aerodrome visits.
- ✓ Encourage the use of proper aviation terminology.
- ✓ Highlight the importance of the Wright Brothers three axis control system.

1.2 Safety in the Aviation Workplace

a) General Rules Related to Personal Safety:

✓ Personal Protective Equipment (PPE):

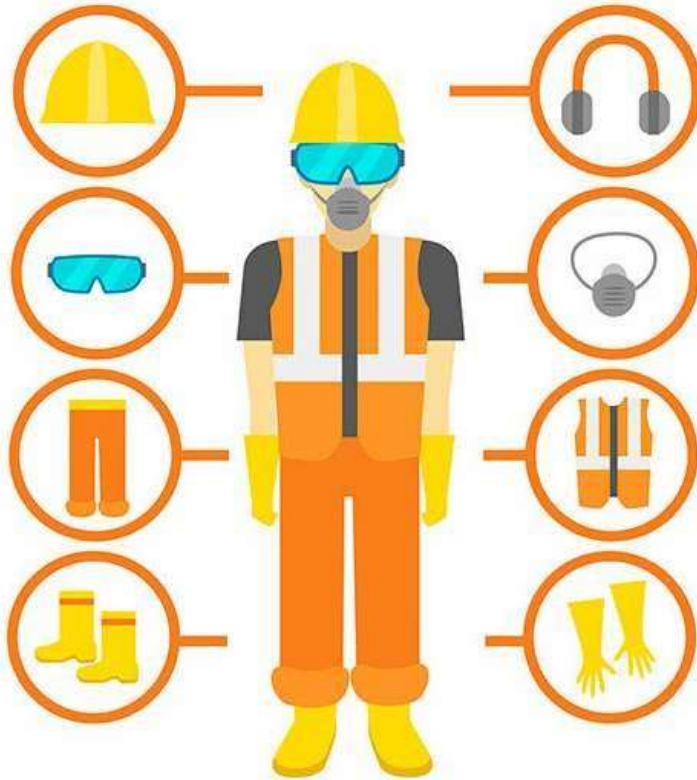

- ✦ Always wear appropriate PPE, including:
 - ❖ Safety glasses: To protect eyes from debris.
 - ❖ Hearing protection: To prevent hearing damage from loud noises.
 - ❖ Safety shoes: To protect feet from falling objects.
 - ❖ Gloves: To protect hands from chemicals and sharp objects.
 - ❖ High-visibility vests: To ensure visibility in busy areas.
 - ❖ Example picture of PPE:



[Image of Personal Protective Equipment (PPE) in an aviation setting]

✓ **Housekeeping:**

- ✚ Maintain a clean and organized workspace.
- ✚ Keep walkways clear of obstructions.
- ✚ Clean up spills immediately.

✓ **Following Procedures:**

- ✚ Adhere to all safety protocols and procedures.
- ✚ Never take shortcuts.
- ✚ Always read and understand all manuals.

✓ **Awareness:**

- ✚ Be aware of your surroundings.
- ✚ Pay attention to warning signs and labels. Report any hazards immediately.

b) Hazards Related to Personal Safety:

□ **Physical Hazards:**

- ✓ Moving machinery: Propellers, engines, and other equipment.
- ✓ Falling objects: Tools, parts, and equipment.
- ✓ Slippery surfaces: Oil spills, wet floors.
- ✓ Loud noises: Engine noise, heavy machinery.
- ✓ Extreme temperatures: Hot engines, cold weather. ✓ Example picture of a workplace hazard.



- [Image of Aviation workplace hazards] □ **Chemical Hazards:**

FOR MORE RESOURCES cbckenyahub.com

- ✓ Fuels: Jet fuel, aviation gasoline.
- ✓ Solvents: Cleaning agents, degreasers.
- ✓ Lubricants: Oils, greases.
- ✓ Example picture of chemical hazards labels.

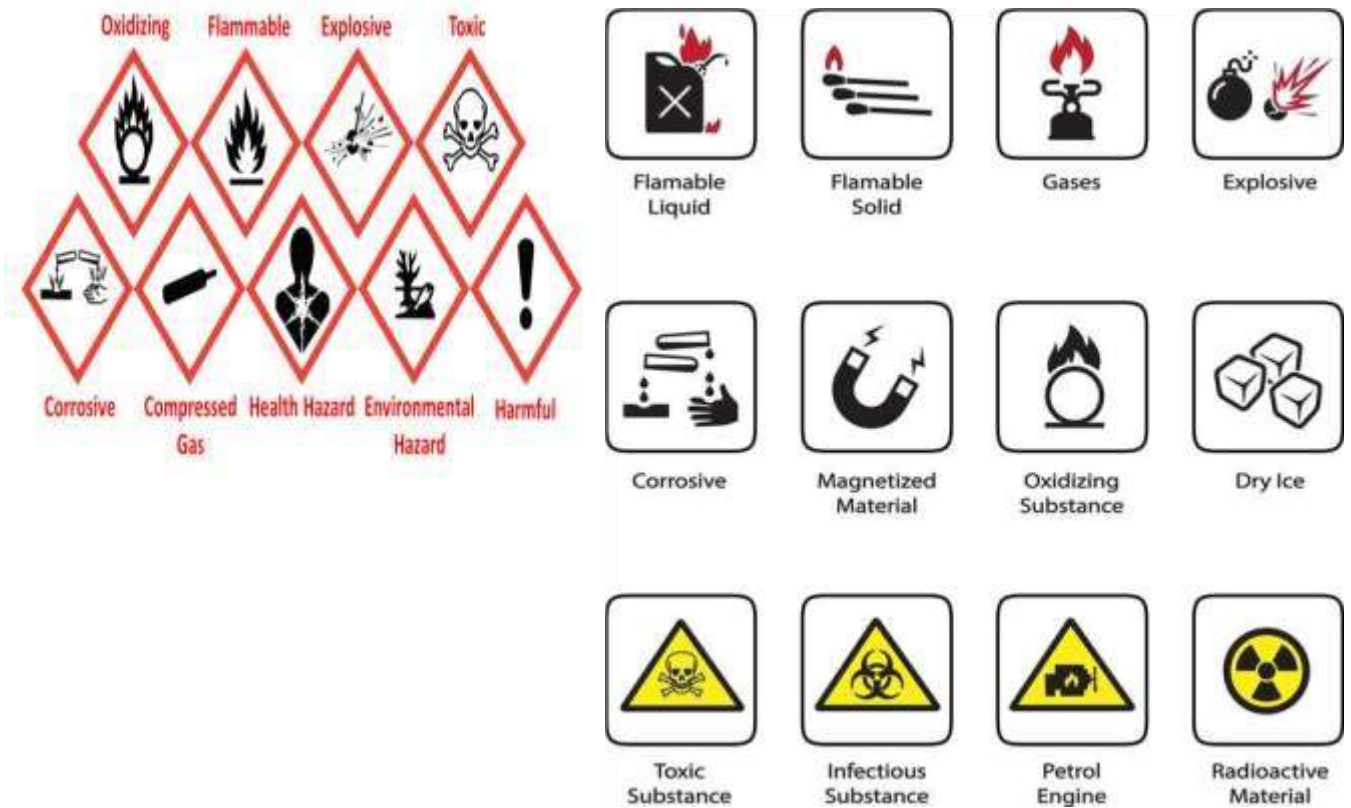

[Image of chemical hazard labels]

- **Electrical Hazards:**

FOR MORE RESOURCES cbkenyahub.com

- ✓ High-voltage equipment.
- ✓ Faulty wiring.
- ✓ Static electricity.



• **Ergonomic Hazards:**

- ✓ Repetitive motions.
- ✓ Heavy lifting.
- ✓ Awkward postures.



c) Common Injuries Related to Safety:

□ Cuts and Lacerations:

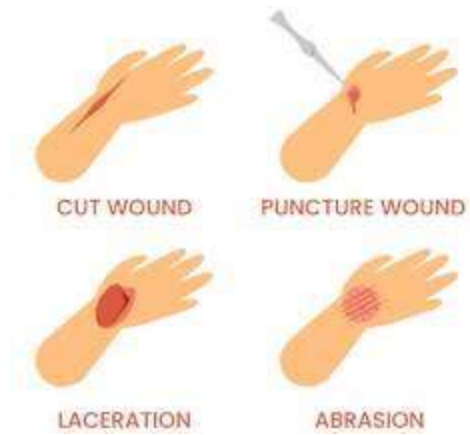

✓ Caused by sharp tools or edges.

□ Burns and Scalds:

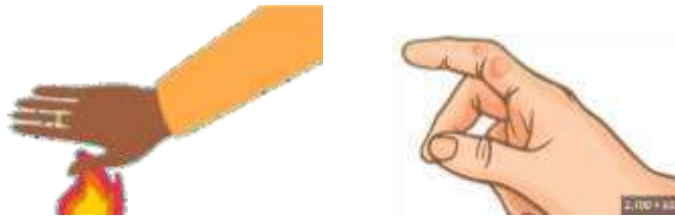

✓ Caused by hot surfaces, chemicals, or fires. □ **Fractures:**



✓ Caused by falls or impacts.

□ Electric Shock Injuries:



✓ Caused by contact with electricity. □ **Sprains and Strains:**



✓ Caused by over exertion, or improper lifting.

Classification of Injuries:

□ **Minor:**

✓ Small cuts, bruises, minor burns.

□ **Serious:**

✓ Fractures, deep cuts, severe burns, electric shock.

□ **Fatal:**

✓ Electrocution, major trauma, severe burns resulting in death.

d) First Aid Procedures:

□ Cuts:



- ✓ Clean the wound with antiseptic.
- ✓ Apply pressure to stop bleeding.
- ✓ Bandage the wound. □ **Burns:**



- ✓ Cool the burn with running water.
- ✓ Cover the burn with a sterile dressing. ✓ Do not apply creams or ointments.

□ Fractures:



- ✓ Immobilize the injured limb.
- ✓ Seek medical attention immediately.

□ Electric Shock:

FOR MORE RESOURCES cbckenyahub.com

FIRST AID FOR ELECTRIC SHOCK

First make safe

Do not touch the casualty with your unprotected hands. Break the contact by switching off the current, removing the plug or wrenching the cable free.



If this is not possible:

- stand on a dry insulating material, such as a wooden pallet or plastic mat, then use a dry wooden or plastic implement to free the casualty from contact with the electrical source; or
- wear rubber or plastic insulating gloves to pull the casualty free; or
- if dry rope is available, without touching the casualty, loop it around the feet or under the arms and pull the casualty free.

How to call an ambulance

A Airway

To open the airway:

- place one hand on the casualty's forehead and gently tilt the head back;
- lift the chin with two fingertips.



B Breathing

Look, listen and feel for normal breathing for no more than 10 seconds:

- look for chest movement;
- listen at the casualty's mouth for breath sounds;
- feel for air on your cheek.



If the casualty is breathing normally,

- place in the recovery position;
- get help;
- check for continued breathing.

If the casualty is not breathing normally:

- get help; call for an AED if available;
- start chest compressions (see CPR).

C CPR

To start chest compressions:

- lean over the casualty and with your arms straight, press down on the centre of the breastbone 5-6 cm, then release the pressure;
- repeat at a rate of about 100-120 times a minute;
- after 30 compressions open the airway again.



- pinch the casualty's nose closed and allow the mouth to open;
- take a normal breath and place your mouth around the casualty's mouth, making a good seal;
- blow steadily into the mouth while watching for the chest rising;
- remove your mouth from the casualty and watch for the chest falling;
- give a second breath and then start 30 compressions again without delay;
- use AED in accordance with manufacturer's instructions;
- continue with chest compressions.

- ✓ Turn off the power source.
- ✓ Check for breathing and pulse.
- ✓ Perform CPR if necessary.
- ✓ Seek medical attention immediately.

□ **Cardiopulmonary Resuscitation (CPR):**

FOR MORE RESOURCES cbckenyahub.com

- ✓ Used when a person's heart has stopped.
 - ✓ Involves chest compressions and rescue breaths. ✓
- Example picture of CPR.

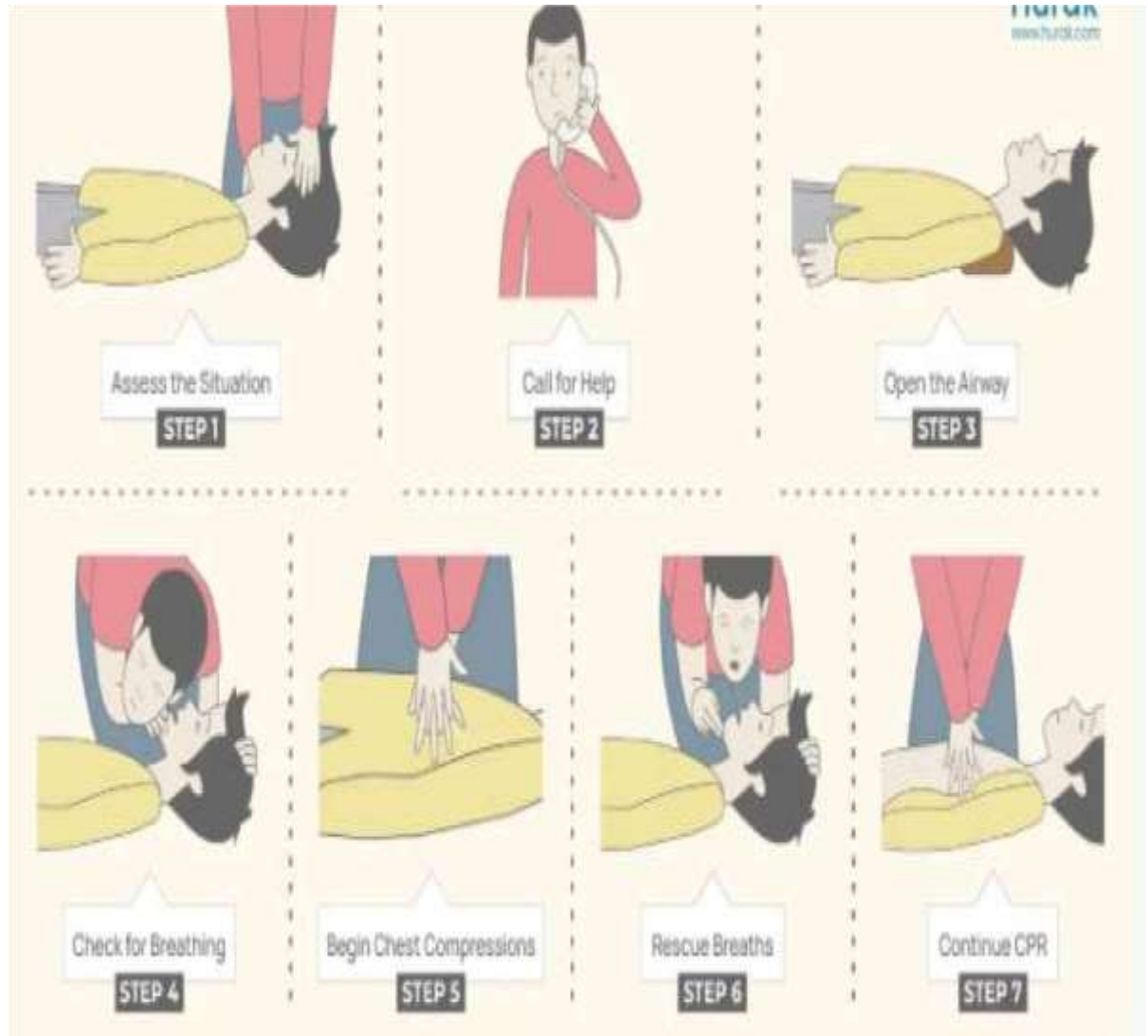

[Image of CPR steps]

□ **First Aid Kit Contents:**

- ✓ Bandages, antiseptic wipes, sterile dressings, adhesive tape, scissors, gloves, CPR mask.

FOR MORE RESOURCES cbckenyahub.com

- ✓ Example Picture of a first aid kit.



[Image of a first aid kit]

e) Role of Safety in the Aviation Workplace:

- ✓ Prevention of accidents and injuries.

FOR MORE RESOURCES cbckenyahub.com

- ✓ Protection of personnel and equipment.
- ✓ Maintenance of a safe and efficient work environment.
- ✓ Compliance with regulations.
- ✓ Reduction of workplace liability.

Aerodrome Visit:

- Observe safety practices such as:
 - ✓ Ground handling safety.
 - ✓ Fueling procedures.
 - ✓ Aircraft maintenance safety. ✓ Air traffic control safety.

Resource Person Engagement:

- Learn from experienced professionals about:
 - ✓ Safety regulations and procedures.
 - ✓ Real-world safety challenges.
 - ✓ Importance of a safety-first culture.

1.3 Airport Safety

a) Safety Measures in Main Airport Areas:

□ Landside:

- ✓ This area is accessible to the general public (e.g., parking lots, roadways, public transportation areas).
 - ✓ Safety measures include:
 - ✚ Traffic management: Ensuring safe vehicle and pedestrian flow.
 - ✚ Security checkpoints: Screening vehicles and passengers for prohibited items.
 - ✚ Emergency response plans: Procedures for handling accidents and emergencies.
- Example picture of Landside area.



- ✓ [Image of Airport Landside area with vehicles and pedestrians] □ **Terminal:**
- ✓ This is the building where passengers check in, go through security, and wait for flights.
- ✓ Safety measures include:
 - ✚ Security screening: X-ray machines, metal detectors, and patdowns.
 - ✚ Crowd control: Managing passenger flow to prevent congestion.
 - ✚ Fire safety: Smoke detectors, sprinkler systems, and evacuation plans.
 - ✚ Baggage handling safety.
 - ✚ Example picture of airport terminal.



[Image of Airport Terminal with passengers and security checkpoints]

□ **Airside:**

- ✓ This is the area where aircraft operate (e.g., runways, taxiways, aprons).
 - ✓ Safety measures include:
 - ✚ Ground handling safety: Proper procedures for servicing and moving aircraft.
 - ✚ Foreign object debris (FOD) prevention: Removing debris from runways and taxiways.
 - ✚ Aircraft movement control: Air traffic control and ground control.
 - ✚ Fueling safety: Proper procedures for handling aviation fuel.
- Example picture of Airside area.



[Image of Airport Airside area with aircraft and ground crew]

b) Common Safety Signs in Airport Areas:

□ **Mandatory Signs:**

- ✓ These signs indicate actions that must be taken.
- ✓ Examples: "Authorized Personnel Only," "Wear Hearing Protection." ✓ Example picture of mandatory sign.



[Image of mandatory airport safety sign]

□ **Prohibition Signs:**

- ✓ These signs indicate actions that are not allowed. ✓ Examples: "No Smoking," "No Entry." ✓ Example picture of prohibition sign.



[Image of prohibition airport safety sign]

□ **Information Signs:**

- ✓ These signs provide general information or directions.
- ✓ Examples: "First Aid," "Emergency Exit," "Fire Extinguisher."
- ✓ Example picture of information sign.



[Image of information airport safety sign]

□ **Warning signs.**

- ✓ These signs give warning of possible dangers.
- ✓ Example: "Caution, jet blast"
- ✓ Example picture of warning sign.



□ [Image of warning airport safety sign]

c) General Safety Rules Related to Movement:

✚ **Landside:**

- ✓ Follow traffic signs and signals.
- ✓ Use designated crosswalks.
- ✓ Be aware of vehicles and pedestrians.

✚ **Terminal:**

- ✓ Follow security instructions.
- ✓ Stay within designated areas.
- ✓ Be aware of baggage carts and other obstacles.

✚ **Airside:**

- ✓ Only authorized personnel are allowed.
- ✓ Follow ground crew instructions.
- ✓ Be aware of aircraft movement.
- ✓ Never cross active runways or taxiways without authorization. ✓ Be aware of Jet Blast and prop wash.

d) Demonstrating General Safety Measures:

□ **Role-playing:**

- ✓ Simulate passenger check-in and security screening.
- ✓ Practice emergency evacuation procedures.
- ✓ Demonstrate proper ground handling procedures.
- ✓ Demonstrate proper FOD prevention techniques.

□ **Aerodrome Visit:**

- ✓ Observe ground handling operations.
- ✓ Observe air traffic control operations.
- ✓ Observe fueling operations.
- ✓ Observe security operations.

e) Careers Related to Airport Safety:

□ **Airport Security Officer:**

- ✓ Screens passengers and baggage.
- ✓ Monitors surveillance systems.
- ✓ Responds to security incidents.

□ **Air Traffic Controller:**

- ✓ Directs aircraft movement on the ground and in the air.
- ✓ Ensures safe separation between aircraft.

□ **Ground Handling Staff:**

- ✓ Services and moves aircraft on the ground.

FOR MORE RESOURCES cbckenyahub.com

- ✓ Ensures safe loading and unloading of baggage.

□ **Airport Firefighter:**

- ✓ Responds to airport emergencies.
- ✓ Extinguishes fires.

□ **Airport Safety Manager:**

- ✓ Develops and implements airport safety policies.
- ✓ Conducts safety audits and inspections.

2.0 AIRCRAFT BASIC CONSTRUCTION

2.1 Aircraft Components

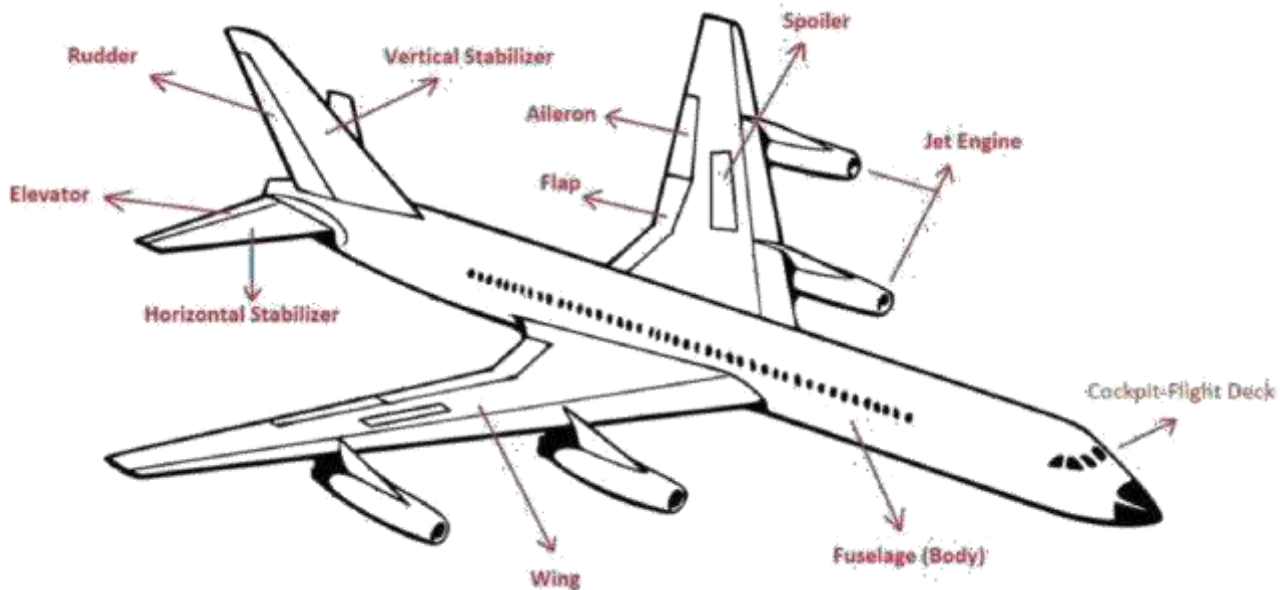

a) **Functions of the Parts of an Aircraft:**

□ **Fuselage:**

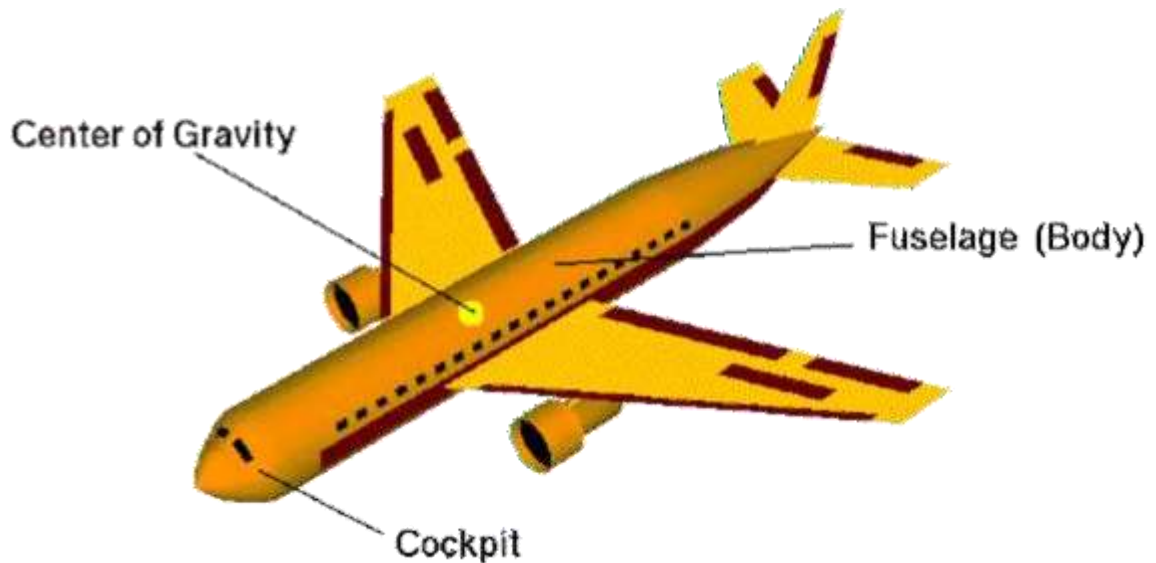

- ✓ The main body of the aircraft.
- ✓ Houses the cockpit, passenger cabin, and cargo compartments.
- ✓ Provides structural support for other components.
- ✓ Example picture of a fuselage. □ **Wings:**

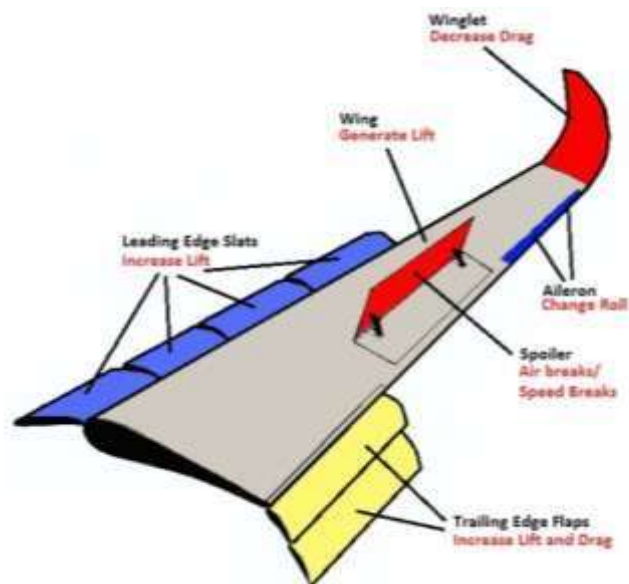

- ✓ Generate lift, which allows the aircraft to fly.
- ✓ Can be fixed (on airplanes) or rotating (on helicopters).
- ✓ May include control surfaces like ailerons and flaps.
- ✓ Example picture of aircraft wings. □ **Empennage (Tail Section):**

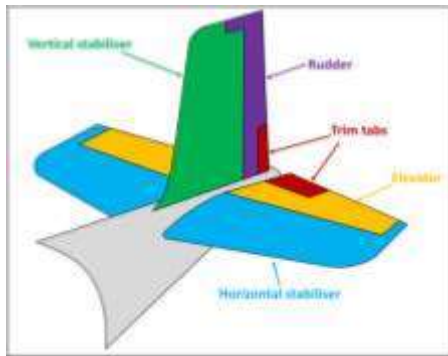

- ✓ Provides stability and control.
- ✓ Includes the vertical stabilizer (tail fin) and horizontal stabilizer.
- ✓ Control surfaces like the rudder and elevators are located here.
- ✓ Example picture of aircraft empennage.

□ **Landing Gear:**

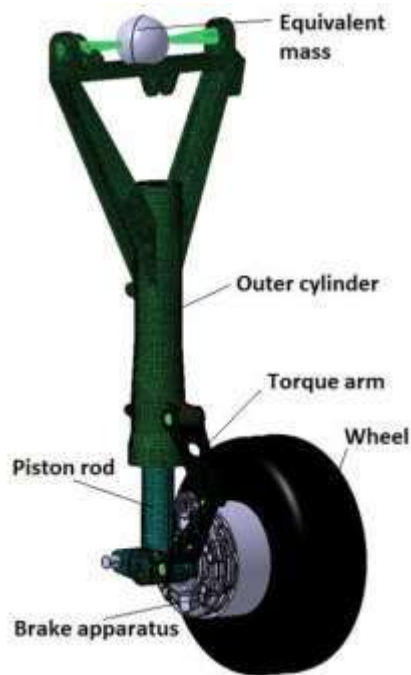

- ✓ Supports the aircraft on the ground during takeoff and landing.
- ✓ Can be fixed or retractable.
- ✓ Includes wheels, struts, and brakes.
- ✓ Example picture of aircraft landing gear. □ **Power Plant**

(Engine/Main Rotor):

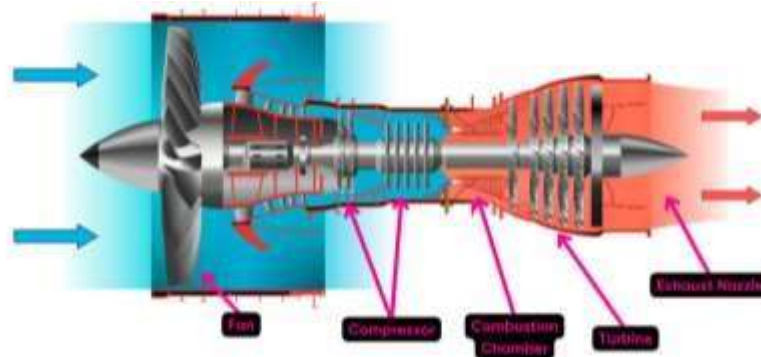

- ✓ Provides thrust or lift.
- ✓ Engines (jet or propeller) for airplanes.
- ✓ Main rotor for helicopters.
- ✓ Example picture of aircraft engine.

□ Tail Rotor (Helicopters):

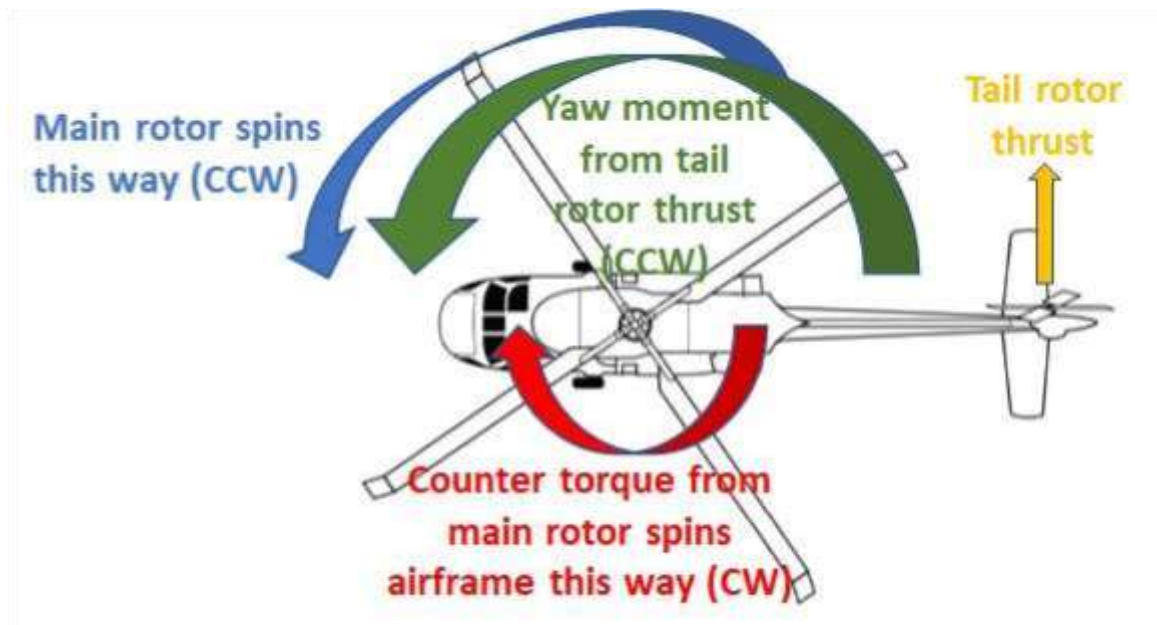

- ✓ Counteracts the torque of the main rotor.
- ✓ Provides directional control for helicopters. ✓
- Example picture of helicopter tail rotor.

b) Illustrating the Parts of an Aircraft:

□ Fixed-Wing Aircraft:

FOR MORE RESOURCES cbckenyahub.com

- ✓ Learners should be able to sketch the major components (fuselage, wings, empennage, landing gear, power plant).
- ✓ Example sketch of a fixed wing aircraft.

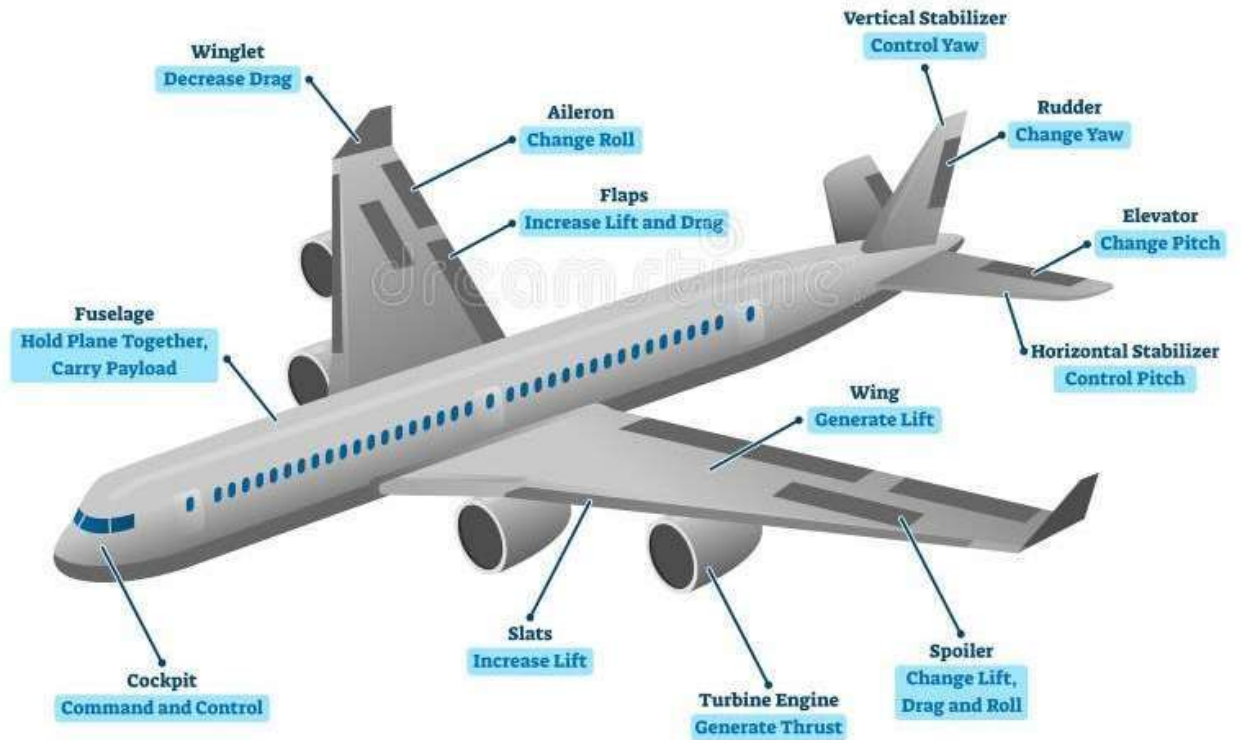

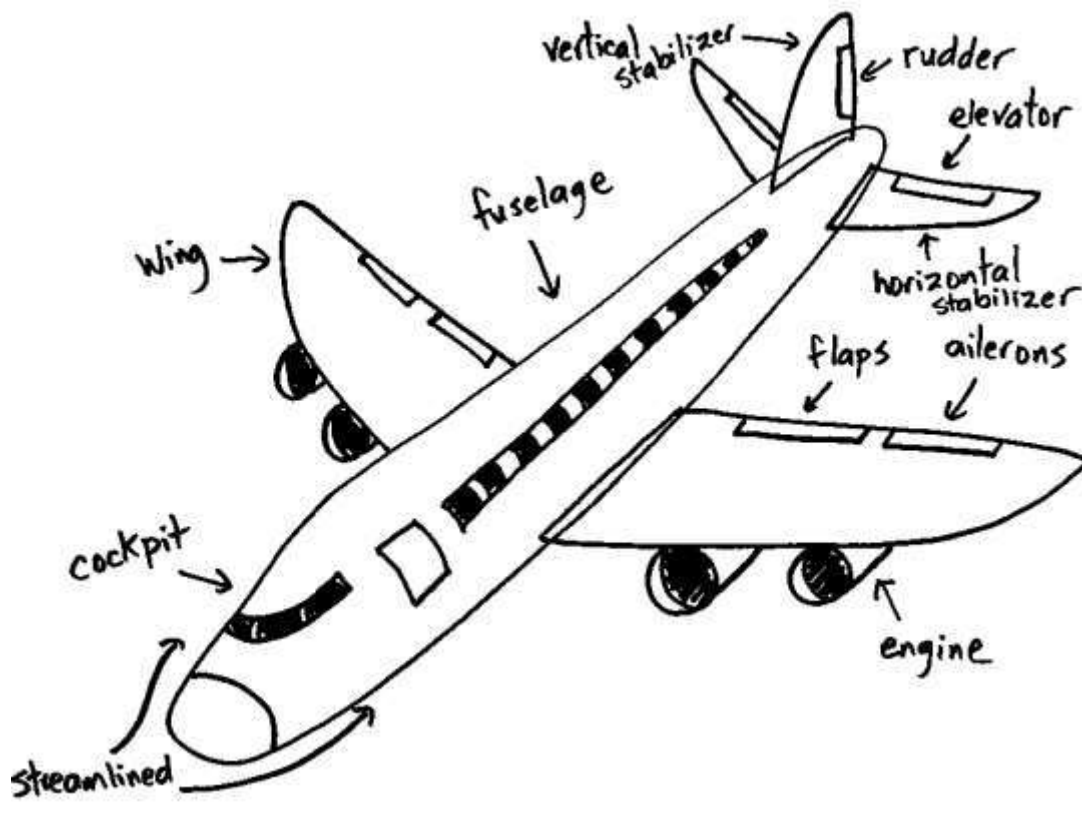

□ **Rotary-Wing Aircraft (Helicopters):**

✓ Learners should be able to sketch the major components (fuselage, main rotor, tail rotor, landing gear, power plant). ✓ Example sketch of a rotary wing aircraft.

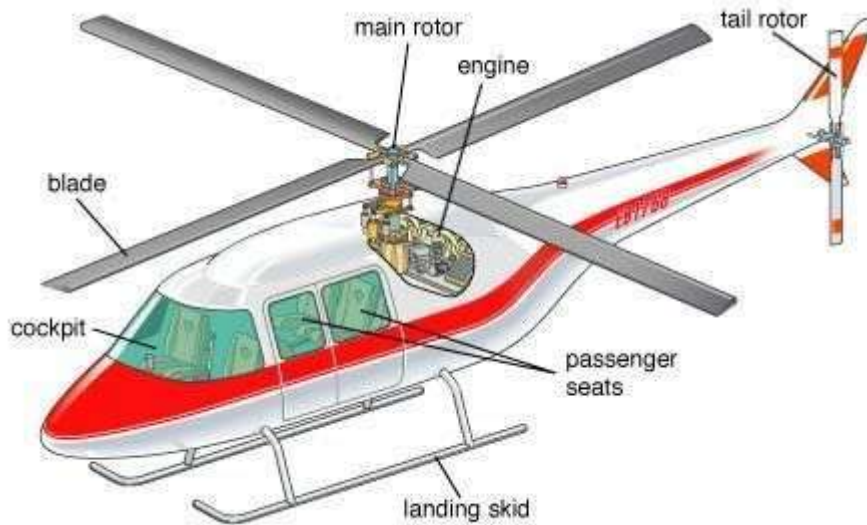

© 2006 Encyclopædia Britannica, Inc.

Question

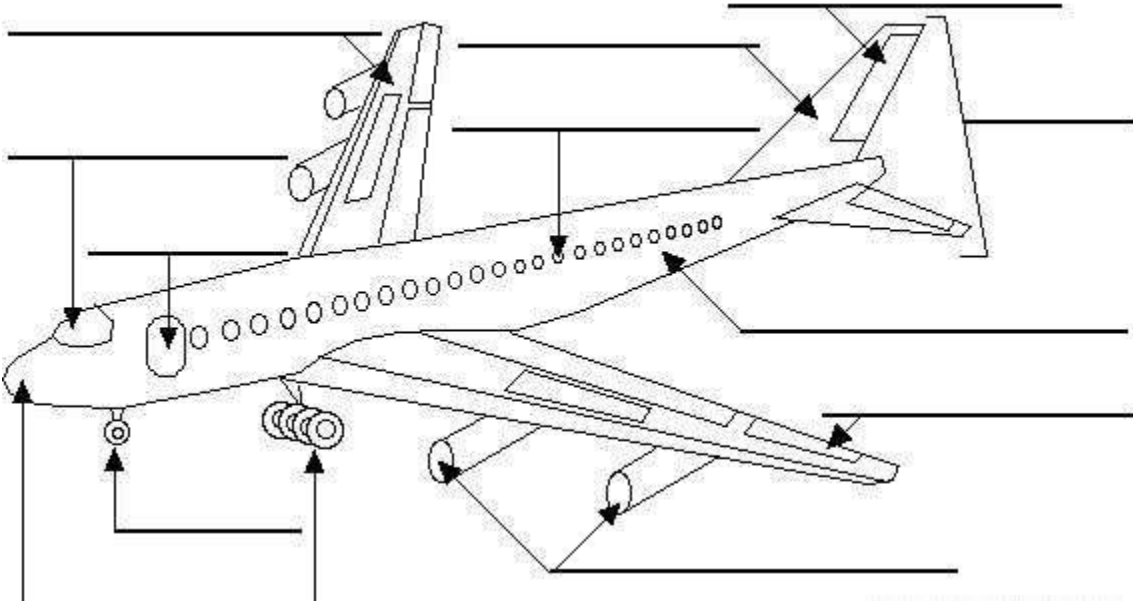

c) Modeling a Heavier-Than-Air Aircraft:

- Using locally available materials (cardboard, paper, sticks, etc.), learners can create models of:
 - ✓ Airplanes: Focusing on the wing and fuselage design.
 - ✓ Helicopters: Focusing on the rotor systems.
- This activity encourages hands-on learning and reinforces understanding of aircraft structure.

d) Role of Different Parts in Aircraft Operation:

- ✓ The resource person can explain how each part contributes to:
 - ✚ Lift generation.
 - ✚ Stability and control.
 - ✚ Propulsion.
 - ✚ Ground operations.
 - ✓ Why does an aircraft have different parts?

Each part is essential to allow for controlled flight. The wings provide lift, the tail section provides stability, the engine provides thrust, and the landing gear allows the aircraft to take off and land safely.

✓ Why are some aircrafts regarded as lighter-than-air?

- ✚ Lighter-than-air aircrafts, like hot air balloons and blimps, use buoyancy to float. They are filled with gasses that are less dense than the surrounding air. Heavier-than-air aircrafts, like airplanes and helicopters, use aerodynamics to generate lift.

2.2 Aircraft Tools and Materials

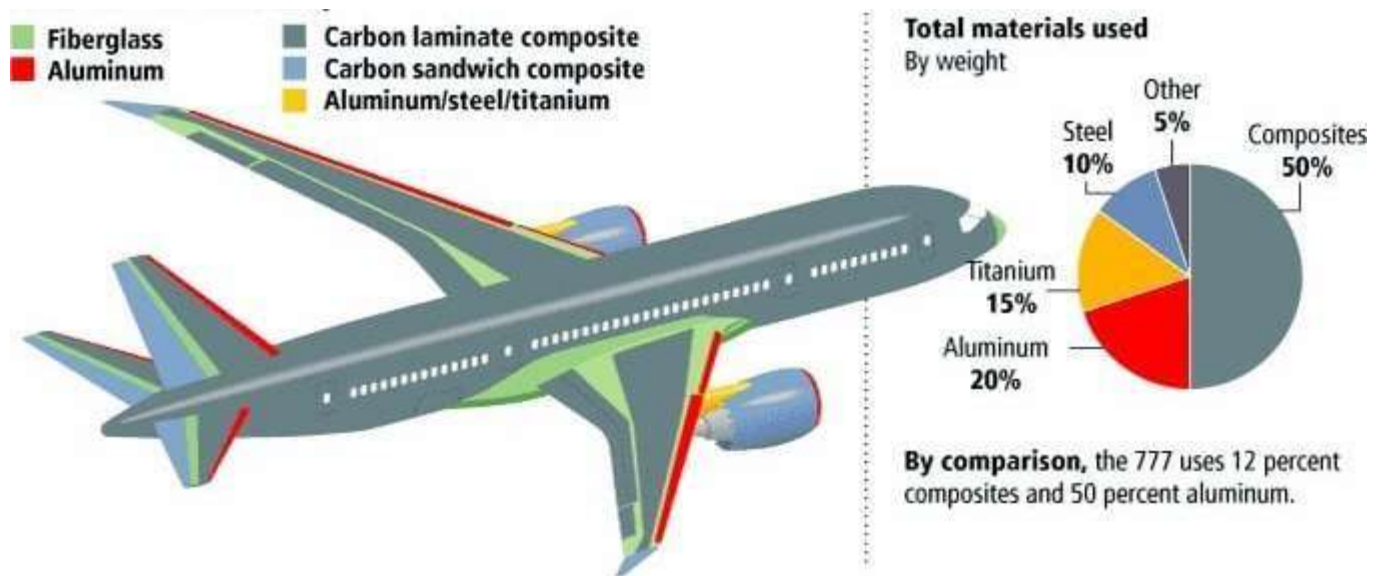

a) Properties of Common Materials Used in Aircraft Construction:

□ Metals:

✓ Aluminum Alloys:

- Properties: Lightweight, high strength-to-weight ratio, corrosion resistance.
- Uses: Fuselage, wings, skin panels.
- Example picture of Aluminium Alloy.



✓ **Steel Alloys:**

- Properties: High strength, high hardness, high temperature resistance.
- Uses: Landing gear, engine mounts, structural components.



✓ **Titanium Alloys:**

- Properties: Very high strength-to-weight ratio, excellent corrosion resistance, high temperature resistance.
- Uses: High-stress components, engine parts.
 - Example picture of Titanium Alloy.



• **Non-Metals:**

✓ **Composites (Carbon Fiber, Fiberglass):**

- Properties: Lightweight, high strength, customizable shapes.
- Uses: Fuselage, wings, control surfaces. ▪
Example picture of Carbon Fiber.



✓ **Plastics:**

- Properties: Lightweight, moldable, various properties depending on type.
- Uses: Interior components, non-structural parts.



• **Properties to Consider:**

- ✓ **Physical Properties:** Density, melting point, thermal conductivity, corrosion resistance.
- ✓ **Mechanical Properties:** Tensile strength, yield strength, hardness, fatigue resistance.

b) Functions of Aircraft Tools:

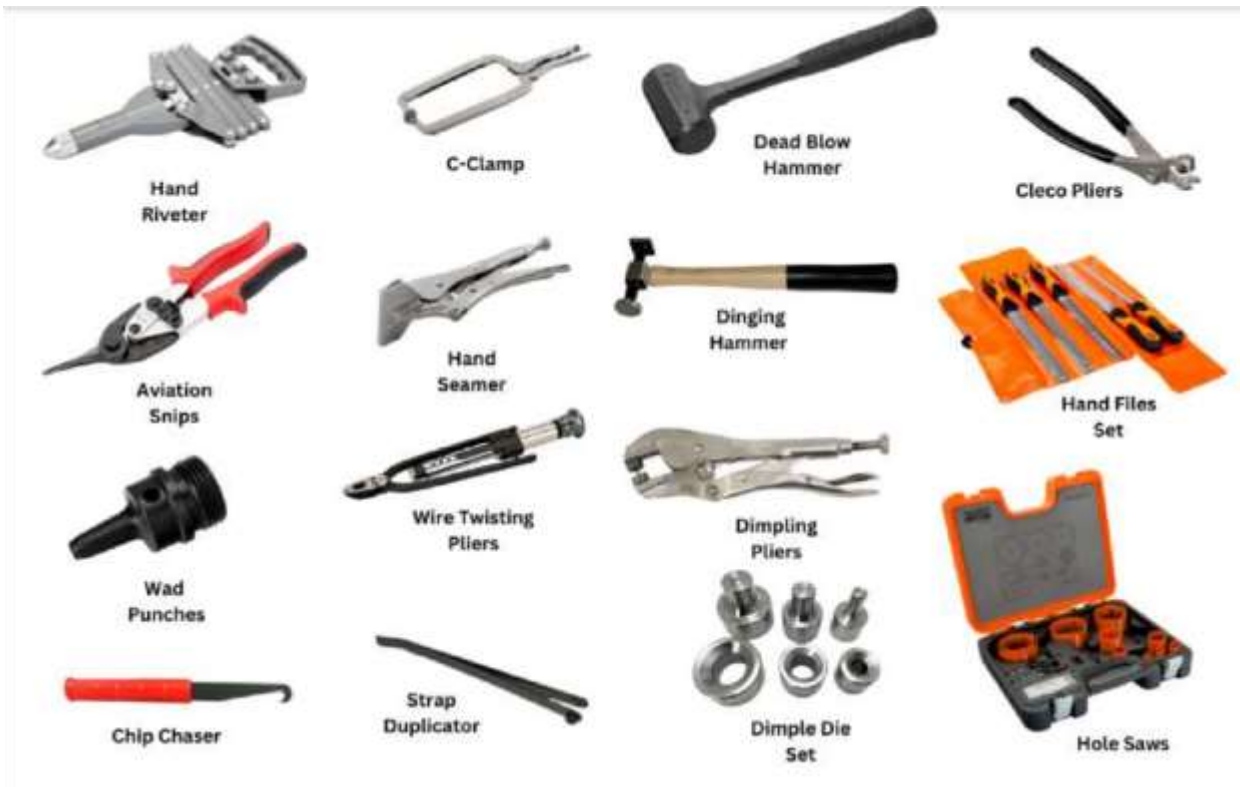

• **Non-Powered Tools:**



- ✓ **Cutting Tools:** Snips, saws, files.

Snips	saws	files



- ✓ **Striking Tools:** Hammers, mallets.

Hammers	mallets



- ✓ **Holding Tools:** Vises, clamps, pliers.

		
Vises	clamps	pliers

- ✓ **Marking Tools:** Scribes, rulers, measuring tapes.

		
Scribes	rulers	measuring tapes

- ✓ **Measuring Tools:** Calipers, micrometers, protractors.

		
Calipers	micrometers	protractors.

- **Powered Tools:**

- ✓ **Drills:** For creating holes.



- ✓ **Riveters:** For joining metal sheets with rivets.



✓ **Grinders:** For smoothing and shaping metal.

✓ **Air tools:** Pneumatic tools for various tasks.



c) Safety Precautions:

- + Wear appropriate PPE (safety glasses, gloves, hearing protection).
 - + Use tools correctly and for their intended purpose.
 - + Inspect tools for damage before use.
 - + Keep tools clean and properly maintained.
 - + Follow manufacturer's instructions for powered tools.
 - + Be aware of surrounding hazards.
- Proper storage of tools.

d) Creating an Aircraft Model:



✓ **Sanders:** For surface preparation.



- ✓ Learners can use materials like:
 - ❖ Aluminum foil, cardboard, wood, plastic sheets.
 - ❖ Adhesives, rivets, screws, bolts.
- ✓ Tools:
 - ❖ Snips, saws, drills, files, hammers.
- ✓ This activity reinforces understanding of aircraft construction and tool usage. **e)**

Tool Maintenance:

- ✓ Cleaning tools after use.
- ✓ Lubricating moving parts.
- ✓ Sharpening cutting tools.
- ✓ Storing tools properly to prevent damage. ✓ Inspection of tools for wear and tear.

f) Excursion to an Aircraft Maintenance Organization:

- ❖ Observe professionals using tools and materials.
- ❖ Learn about real-world aircraft maintenance practices.
- ❖ See various aircraft materials and tools in action.
- ❖ Ask questions and gain insights into the industry.

2.3 Aircraft Related Drawing: Isometric Drawing

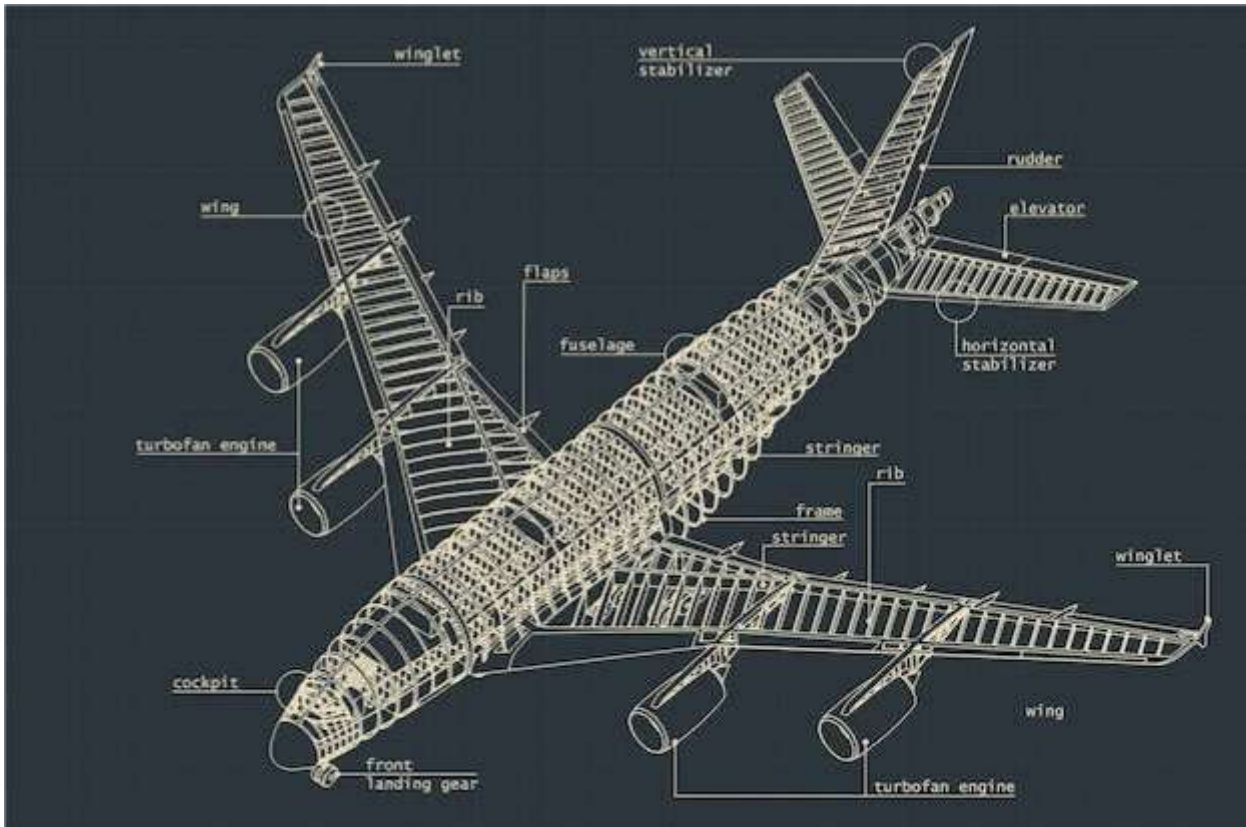

a) Characteristics of Isometric Drawing:

- ✓ **Isometric Projection:** A type of pictorial drawing where all three axes (length, width, and height) are equally foreshortened.
- ✓ **Angles:** All lines are drawn at 30 degrees to the horizontal baseline.
- ✓ **True Lengths:** Measurements are taken along the isometric axes, maintaining true proportions.
- ✓ **Parallel Lines:** Parallel lines in the object remain parallel in the drawing.
- ✓ **Non-Perspective:** Objects do not appear to diminish in size with distance.
- ✓ Example picture of isometric drawing axes.

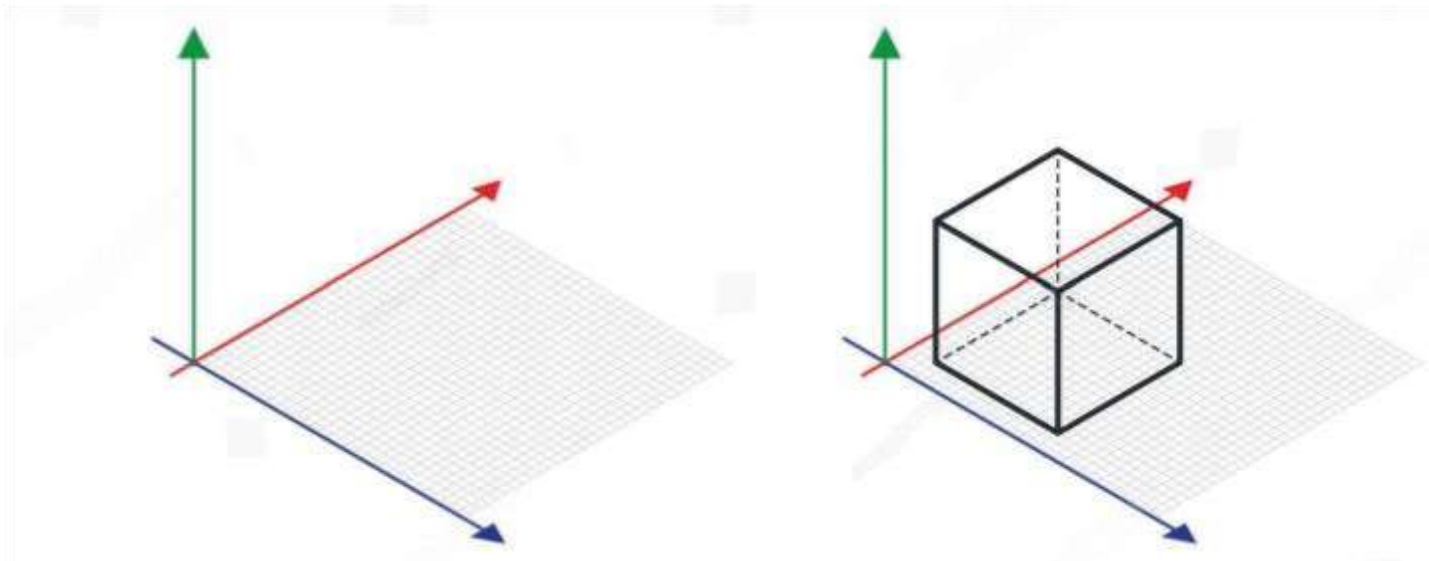

b) Sketching Aircraft Components in Isometric Projection:

- ✓ **Freehand Sketches:** Learners should practice sketching basic aircraft components (fuselage, wings, etc.) in isometric view.
- ✓ **Focus on Maintaining Angles:** Ensure lines are drawn at approximately 30 degrees.
- ✓ **Proportions:** Keep the proportions of the components accurate. ✓ Example sketch of aircraft part.

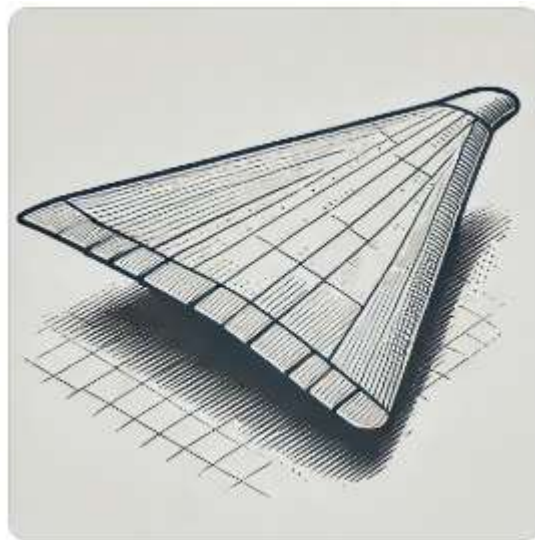

- ✓ [Simple freehand sketch of an aircraft wing in isometric view]

c) Drawing Shaped Blocks in Isometric Projection:

□ Steps:

FOR MORE RESOURCES cbckenyahub.com

1. Draw the isometric axes.
 2. Construct the base of the block.
 3. Draw the vertical lines to represent height.
 4. Complete the top and sides of the block.
 5. Add details and features.
- **Using Drawing Instruments:** Learners should use rulers, set squares, and protractors for accuracy.

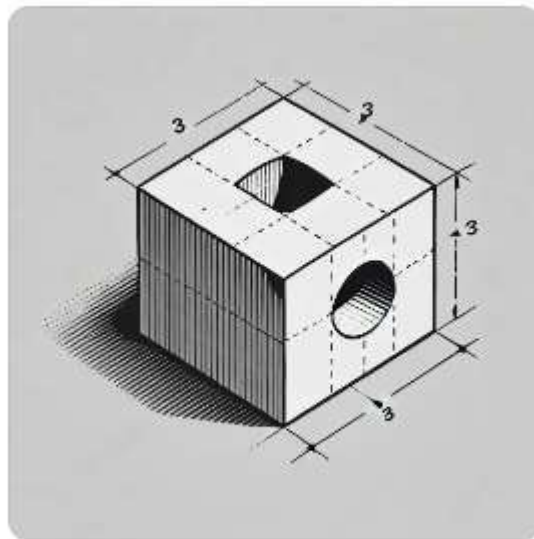

- [Image of an isometric drawing of a shaped block]

d) Dimensioning Isometric Drawings:

- ✓ **Dimension Lines:** Use extension and dimension lines to indicate measurements.
- ✓ **Placement:** Dimensions should be placed outside the object, avoiding clutter.
- ✓ **Alignment:** Dimensions should be aligned and easy to read.
- ✓ **Notes:** Add notes to specify materials, tolerances, or other relevant information.

e) Application of Isometric Projection in Aircraft Construction:

- ❖ **Design and Planning:** Used to visualize and communicate design ideas.
- ❖ **Manufacturing:** Provides clear instructions for creating parts.
- ❖ **Maintenance:** Helps technicians understand the structure and assembly of aircraft components.
- ❖ **Technical Manuals:** Used to illustrate parts and assemblies.

- ❖ **Troubleshooting:** Helps in identifying and resolving problems.
- ❖ **Example Application:**
 - ✓ Isometric drawings of parts and assemblies help technicians understand how components fit together.
 - ✓ They are used in maintenance manuals to illustrate repair procedures. ❖ **Why are isometric drawings important in aircraft construction?**
 - ✓ They provide a clear, three-dimensional representation of aircraft components, aiding in design, manufacturing, and maintenance.
- ❖ **How are isometric drawings used in aircraft construction?**
 - ✓ They are used for visualizing designs, creating technical drawings for manufacturing, and illustrating repair procedures in maintenance manuals.

Visit to an Aircraft Maintenance Facility:

- ✓ Observe how isometric drawings are used in real-world aircraft maintenance.
- ✓ See examples of technical drawings and manuals.
- ✓ Ask questions about the application of isometric projection.

3.0 FLIGHT OPERATIONS

3.1 Aviation Weather



a) Elements of Weather in the Atmosphere:

- **Wind:**

- ✓ Horizontal movement of air.
- ✓ Measured in knots (nautical miles per hour).
- ✓ Affects aircraft speed and direction. ✓ Example picture of windsock.



[Image of windsock at an airport]

- **Temperature:**

- ✓ Degree of hotness or coldness of the air.
- ✓ Measured in Celsius or Fahrenheit.
- ✓ Affects air density and aircraft performance. ✓ Example picture of thermometer.



[Image of a thermometer]

- **Pressure:**

- ✓ Weight of the air above a given point.
- ✓ Measured in millibars (mb) or inches of mercury (inHg).
- ✓ Affects aircraft altitude and performance. ✓ Example picture of barometer.



[Image of a barometer]

- **Humidity:**

FOR MORE RESOURCES cbckenyahub.com

- ✓ Amount of moisture in the air.
- ✓ Measured as a percentage.
- ✓ Affects visibility and aircraft performance. ✓ Example picture of hygrometer.



[Image of a hygrometer]

- **Clouds:**

- ✓ Visible masses of water droplets or ice crystals.
- ✓ Affect visibility and create turbulence.
- ✓ Example picture of clouds.

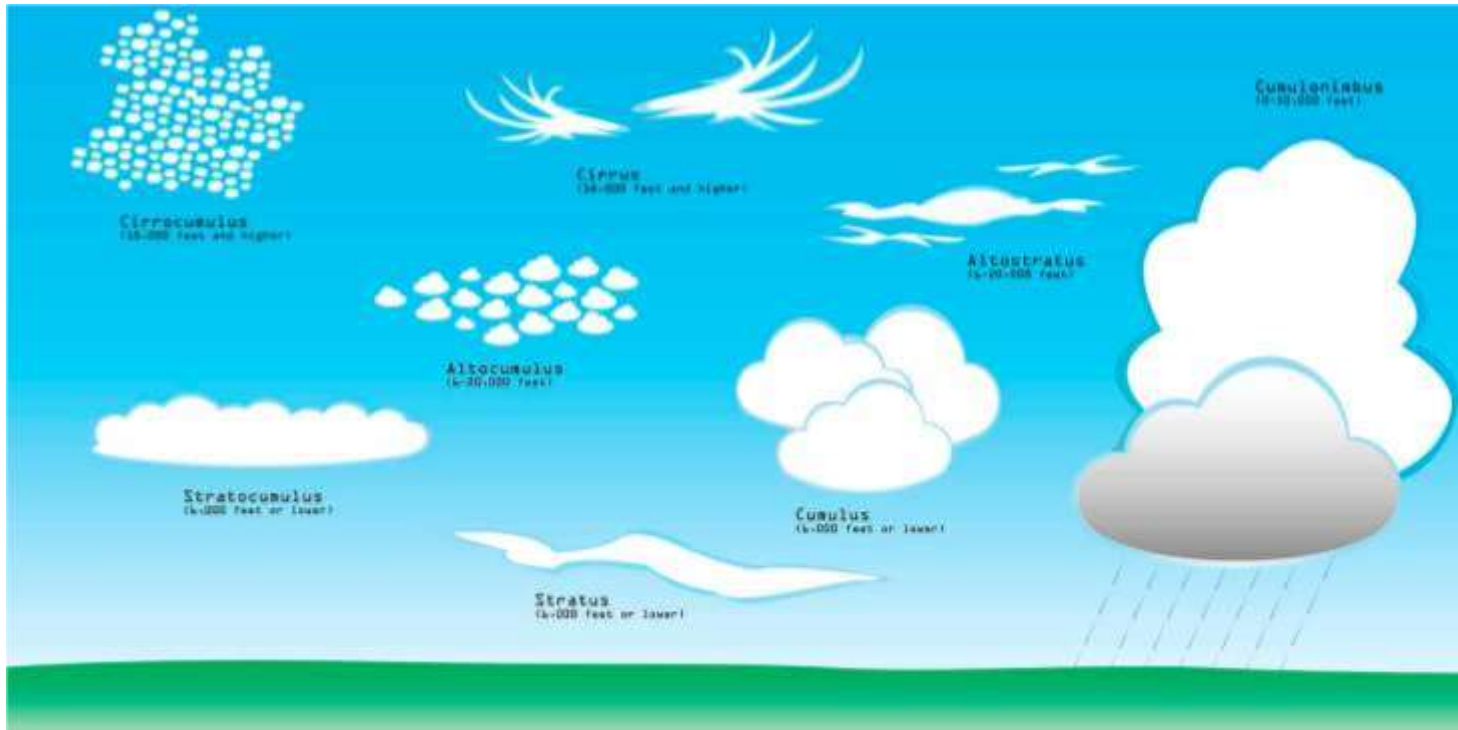

[Image of different types of clouds]

- **Precipitation:**

- ✓ Water falling from clouds (rain, snow, hail, sleet). ✓
- Affects visibility and aircraft performance.



[Image of rain falling]

b) Effects of Weather Elements on an Aircraft in Flight:

- ❖ **Wind:**

- ✓ Headwind: Reduces ground speed, increases fuel consumption.
- ✓ Tailwind: Increases ground speed, reduces fuel consumption.

FOR MORE RESOURCES cbckenyahub.com

- ✓ Crosswind: Can make takeoff and landing difficult.
- ✓ Wind shear: Sudden changes in wind speed and direction, very dangerous.

❖ **Temperature:**

- ✓ High temperature: Reduces air density, decreases engine performance, increases takeoff distance.
- ✓ Low temperature: Increases air density, improves engine performance.

❖ **Pressure:**

- ✓ Low pressure: Reduces air density, decreases aircraft performance.
- ✓ High pressure: Increases air density, improves aircraft performance. ❖

Humidity:

- ✓ High humidity: Reduces air density, decreases aircraft performance.
- ✓ Can cause icing.

❖ **Clouds:**

- ✓ Low clouds: Reduce visibility, can cause instrument flight rules (IFR) conditions.
- ✓ Thunderstorms: Cause severe turbulence, lightning, hail.

❖ **Precipitation:**

- ✓ Rain: Reduces visibility, can cause aquaplaning on runways.
- ✓ Snow: Reduces visibility, can cause icing. ✓ Hail: Can damage aircraft.

c) Types of Clouds in Flight Operations:

□ **Cirrus:**

- ✓ High-altitude, wispy clouds.
- ✓ Composed of ice crystals.
- ✓ Indicate approaching weather changes.



[Image of cirrus clouds]

□ **Stratus:**

- ✓ Low-altitude, layered clouds.
- ✓ Can cause low visibility and drizzle.



[Image of stratus clouds]

□ **Cumulus:**

- ✓ Puffy, cotton-like clouds.
- ✓ Can develop into thunderstorms.



[Image of cumulus clouds]

□ **Cumulonimbus:**

- ✓ Thunderstorm clouds, very dangerous.



[Image of cumulonimbus clouds]

d) Measuring the Elements of Weather:

• **Wind:**

✓ Anemometer: Measures wind speed.



✓ Wind vane: Measures wind direction.

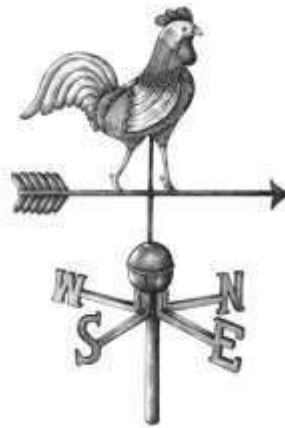

• **Temperature:**

✓ Thermometer: Measures air temperature.

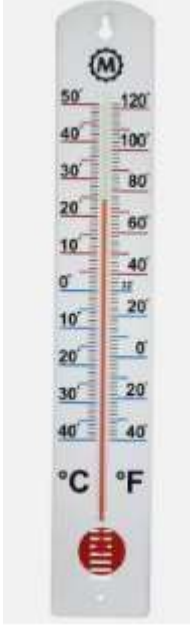

- **Pressure:**

- ✓ Barometer: Measures atmospheric pressure.



- **Humidity:**

- ✓ Hygrometer: Measures humidity.



- **Precipitation:**

- ✓ Rain gauge: Measures rainfall.



e) Role of Aviation Weather in Flight Operations:

- ✓ **Safety:** Weather information is crucial for safe flight operations.
- ✓ **Flight Planning:** Pilots use weather forecasts to plan routes and fuel requirements.
- ✓ **Decision Making:** Pilots make decisions based on real-time weather conditions.

FOR MORE RESOURCES cbckenyahub.com

- ✓ **Efficiency:** Weather information helps optimize flight operations.
- ✓ **Careers:**
 - ❖ Meteorologists: Analyze and forecast weather.
 - ❖ Air Traffic Controllers: Use weather information to manage air traffic. ❖
Flight Dispatchers: Plan flights based on weather conditions.

Visit to a Local Meteorological Department:

- ✚ Observe how weather data is collected and analyzed.
- ✚ Learn about weather forecasting techniques.
- ✚ See the instruments used to measure weather elements. Ask questions about aviation weather.

3.2 Aviation Communication

a) ICAO Phonetics:

- ❖ **Importance:** Ensures clear and unambiguous communication, especially in noisy environments or when language barriers exist.
- ❖ **Letters:**
 - ✓ Alpha, Bravo, Charlie, Delta, Echo, Foxtrot, Golf, Hotel, India, Juliet, Kilo, Lima, Mike, November, Oscar, Papa, Quebec, Romeo, Sierra, Tango, Uniform, Victor, Whiskey, X-ray, Yankee, Zulu.



[Image of the ICAO Phonetic Alphabet chart]

❖ **Numerals:**

- ✓ Nadazero, Unaone, Bissotwo, Terrathree, Kartefour, Pantafive, Soxisix, Setteseven, Oktoeight, Novenine.

❖ **Time:**

- ✓ Spoken in 24-hour format (e.g., 1430 is "one four three zero").

❖ **Call Signs:**

- ✓ Unique identifiers for aircraft and ground stations. ✓ Spoken using ICAO phonetics.

b) Standard Words and Phrases:

□ **Ground-to-Ground:**

- ✓ "Roger": Message received and understood.
- ✓ "Wilco": Will comply.

FOR MORE RESOURCES cbckenyahub.com

- ✓ "Affirm": Yes.
- ✓ "Negative": No.
- ✓ "Standby": Wait.
- ✓ "Go ahead": Proceed with your message.
- ✓ "Say again": Repeat your message.
- ✓ "Read back": Repeat the message to confirm understanding.
- ✓ "Correction": An error has been made, and the following is the corrected version.
- ✓ "Over": My transmission is finished, and I expect a response.
- ✓ "Out": My transmission is finished, and I do not expect a response. □

Example Phrase:



"Tower, Kenya Airways one two three, request taxi to runway two seven, over."

c) Transmission Techniques:

• **Radio Devices:**

- ✓ VHF (Very High Frequency) radios are commonly used.
- ✓ Proper microphone technique: Speak clearly and at a consistent volume. ✓
Use correct phraseology.



- [Image of a VHF Aviation Radio]
 - **Listening and Speaking:**
 - ✓ Listen carefully before transmitting.
 - ✓ Speak slowly and clearly.
 - ✓ Use standard phrases.
 - ✓ Avoid unnecessary chatter.
 - ✓ Maintain situational awareness.

d) Aircraft Marshalling Signals:

- **Purpose:** To guide aircraft on the ground using visual signals.
- **Hand Signals:**
 - ✓ "Stop": Arms extended horizontally.
 - ✓ "Proceed straight ahead": Arms moving forward.
 - ✓ "Turn left/right": Arms indicating direction.
 - ✓ "Slow down": Arms moving up and down.
 - ✓ "Engine start/stop": Specific hand movements.

AIRCRAFT MARSHALLING SIGNALS



- [Image of aircraft marshalling hand signals]

- **Light Signals:**

- ✓ Used at night or in low visibility.

FOR MORE RESOURCES cbckenyahub.com



[Image of an aviation light gun]

□ **Follow-Me Vehicles:**

- ✓ Lead aircraft to parking positions.



□ [Image of an Airport Follow-Me vehicle]

e) Careers Related to Aviation Communication:

✓ **Air Traffic Controller:**

- ❖ Responsible for directing aircraft movement on the ground and in the air.
- ❖ Uses radio communication to give instructions.

✓ **Flight Dispatcher:**

- ❖ Plans flight routes and monitors weather conditions.
- ❖ Communicates with pilots and air traffic control.

✓ **Ground Handling Staff:**

- ❖ Uses marshalling signals to guide aircraft.
- ❖ Communicates with pilots and other ground personnel.

FOR MORE RESOURCES cbckenyahub.com

✓ **Aeronautical Radio Operator:**

- ❖ Transmits and receives messages related to flight operations.

✓ **Communication Engineers:**

- ❖ Maintain and repair communication systems.

Aerodrome Tour:

- ✓ Observe air traffic control communication.
- ✓ Observe ground handling operations.
- ✓ See marshalling signals in use.
- ✓ Learn about different communication systems.

3.3 Aerodynamics of Flight

a) Physical Properties of the Atmosphere:

The atmosphere is a layer of gases surrounding the Earth.

• **Temperature:**

- ✓ Decreases with altitude in the troposphere.
- ✓ Increases with altitude in the stratosphere (°F) ✓ Measured in degrees Celsius (°C) or degrees Fahrenheit ✓ Affects air density and aircraft performance.

• **Pressure:**

- ✓ Force exerted by the weight of air.
- ✓ Measured in pascals (Pa) or inches of mercury.(Hg) ✓ Decreases with altitude.
- ✓ Affects aircraft altitude and performance.

• **Density:**

- ✓ Mass of air per unit volume. ✓ Measured in kg/m³ or g/cm³ ✓ Decreases with altitude.
- ✓ Affects lift and drag.

• **Humidity:**

- ✓ Amount of moisture in the air.
- ✓ Affects air density and engine performance.

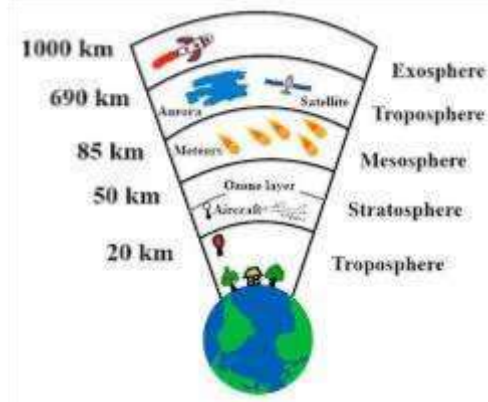

- Example image of atmospheric layers.

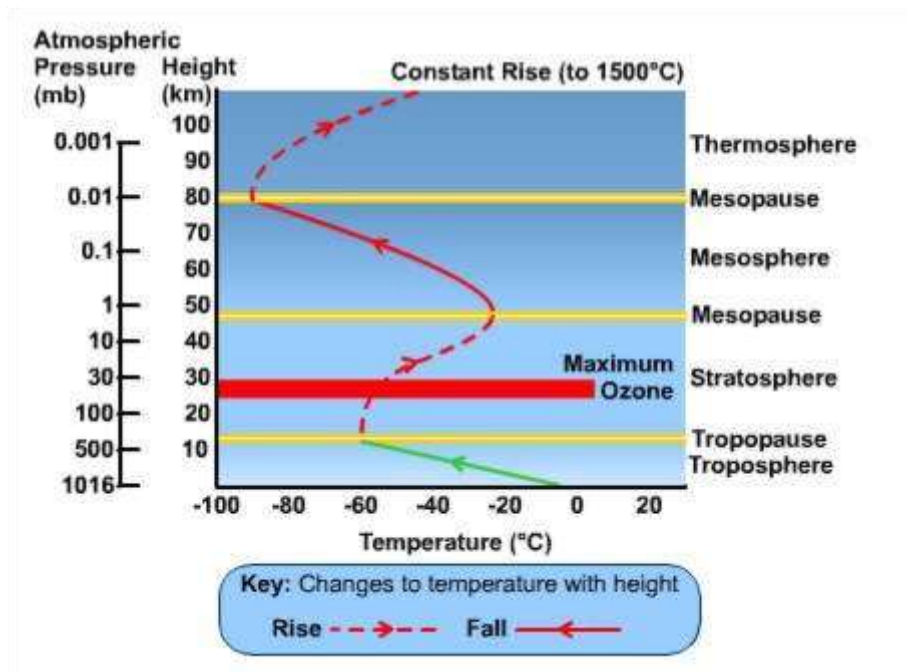

- [Image of Atmospheric Layers showing temperature and pressure changes]

b) Characteristics of the Lower Layers of the Atmosphere:

🚩 Troposphere:

- ✓ Lowest layer, where most weather phenomena occurs.
- ✓ Temperature decreases with altitude. (lapse rate)
- ✓ Contains most of the atmosphere's mass.

🚩 Stratosphere:

- ✓ Above the troposphere.
- ✓ Temperature increases with altitude due to the ozone layer.

FOR MORE RESOURCES cbckenyahub.com

- ✓ Stable air, little weather.

🚀 **International Standard Atmosphere (ISA):**

- ✓ A model of the atmosphere used for aircraft performance calculations.
- ✓ Provides standard values for temperature, pressure, and density at different altitudes.

c) **Axes of an Aircraft:**

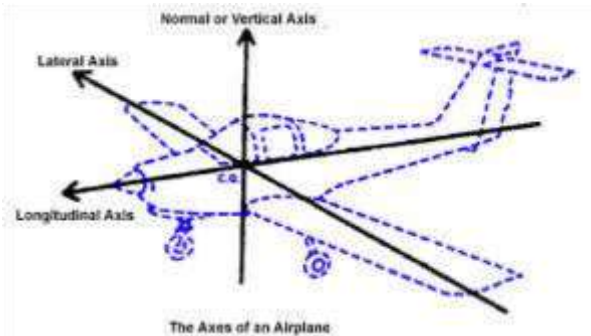

- **Longitudinal Axis (Roll):**

- ✓ Runs from the nose to the tail.
- ✓ Rotation around this axis is called roll. ✓ Controlled by ailerons.



- [Image of an aircraft with the longitudinal axis labeled] □ **Lateral Axis (Pitch):**

- ✓ Runs from wingtip to wingtip.
- ✓ Rotation around this axis is called pitch.
- ✓ Controlled by elevators.

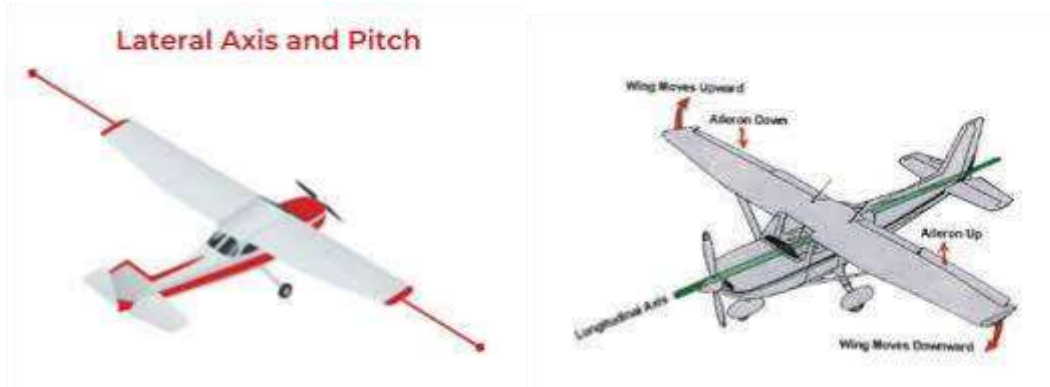

- [Image of an aircraft with the lateral axis labeled]
 - **Vertical Axis (Yaw):**
 - ✓ Runs from the top to the bottom of the aircraft.
 - ✓ Rotation around this axis is called yaw. ✓ Controlled by the rudder.



- [Image of an aircraft with the vertical axis labeled]

Summary



d) Motion of an Aircraft About Its Axes:

- **Roll:**
 - ✓ Tilting the wings to the left or right.
 - ✓ Causes the aircraft to bank.
- **Pitch:**
 - ✓ Raising or lowering the nose of the aircraft.
 - ✓ Causes the aircraft to climb or descend.
- **Yaw:**
 - ✓ Moving the nose of the aircraft left or right.
 - ✓ Causes the aircraft to turn.
- **Aircraft Model Demonstration:**
 - ✓ Use a model to physically show how the aircraft moves around each axis.

e) Forces That Act on an Aircraft in Flight:

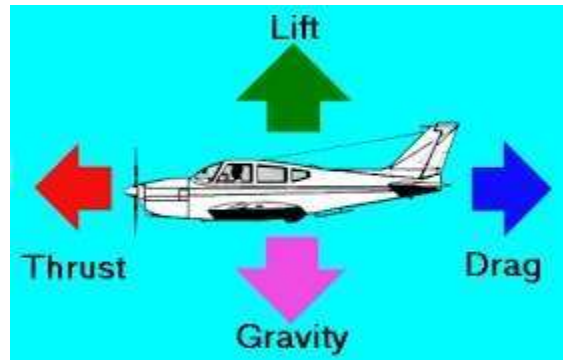

- ✓ **Lift:**
- ✓ Upward force generated by the wings. ✓
- ✓ Opposes weight.

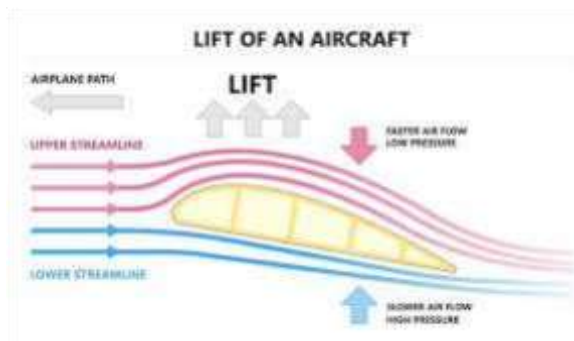

- ✓ [Image of lift force on an aircraft wing] ✓
- ✓ **Thrust:**
- ✓ Forward force generated by the engine. ✓
- ✓ Opposes drag.

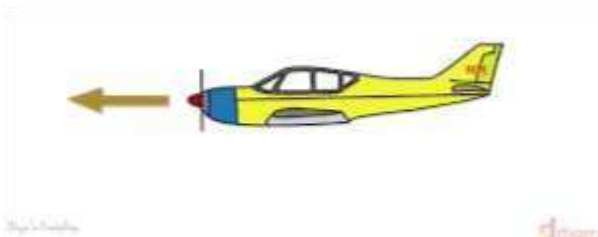

- ✓ [Image of thrust force on an aircraft from an engine] ✓
- ✓ **Weight:**
- ✓ Downward force due to gravity.
- ✓ Opposes lift.



- ✓ [Image of weight force on an aircraft] ✓

Drag:

- ✓ Rearward force that opposes motion. ✓
Caused by air resistance.



- ✓ [Image of drag force on an aircraft]

f) Effects of Aerodynamic Forces:

- ✓ **Lift:** Allows the aircraft to overcome gravity and fly.
- ✓ **Thrust:** Propels the aircraft forward.
- ✓ **Weight:** Pulls the aircraft downward.
- ✓ **Drag:** Slows the aircraft down.
- ✓ **Balanced Forces:** In steady flight, these forces are balanced.
- ✓ **Unbalanced Forces:** Cause the aircraft to accelerate or change direction.



Aerodrome Excursion:

- ✓ Observe aircraft in flight and during takeoff and landing.
- ✓ See how aerodynamic forces affect aircraft movement.
- ✓ Ask questions about aircraft control and flight dynamics.

4.0 AIRPORT OPERATIONS

4.1 The Airport



a) Categories of Airports in Aviation:

- Airports are categorized based on factors such as runway length, passenger volume, and the types of aircraft they serve.
- **ICAO (International Civil Aviation Organization) Categories:**

- ✓ **Category A:**



- Small airports, often for general aviation.
- Short runways, limited facilities.

FOR MORE RESOURCES cbckenyahub.com

- Example: Small local airstrips like Kitale, Maasai Mara, Mandera, Laikipia airstrip.

✓ **Category B:**

- Regional airports, serving smaller commercial aircraft.
- Moderate runway length and facilities.
- Example: Wilson Airport, Eldoret Regional Airport .



✓ **Category C:**

- Medium-sized airports, serving larger commercial aircraft.
- Longer runways, more extensive facilities.
- Example: Kisumu International Airport , Moi International Airport.



✓ **Category D:**

- Large international airports, serving a wide range of aircraft.
- Long runways, extensive facilities, high passenger volume.
- Example: Large international hubs. Jomo Kenyatta international airport



✓ **Category E:**

- Very large international airports, capable of handling the largest aircraft (e.g., A380).
- Very long runways, state-of-the-art facilities.
- Example: Major international hubs with extremely high passenger traffic.



- [eg Hartsfield-Jackson Atlanta International Airport (ATL) in Atlanta, Georgia, USA, King Fahd International Airport

b) Functions of Major Airport Areas:

□ **Landside:**

- ✓ Area accessible to the general public.

✓ Functions:

- ✚ Passenger drop-off and pick-up.
- ✚ Parking facilities.
- ✚ Public transportation access.
- ✚ Check-in counters.

Example image of landside airport area.

□ **Terminal:**

✓ Building where passengers check in, go through security, and wait for flights.

✓ Functions:

- ✚ Security screening.
- ✚ Baggage handling.
- ✚ Passenger waiting areas.
- ✚ Retail and dining facilities.
- ✚ Boarding gates.

Example image of airport terminal.

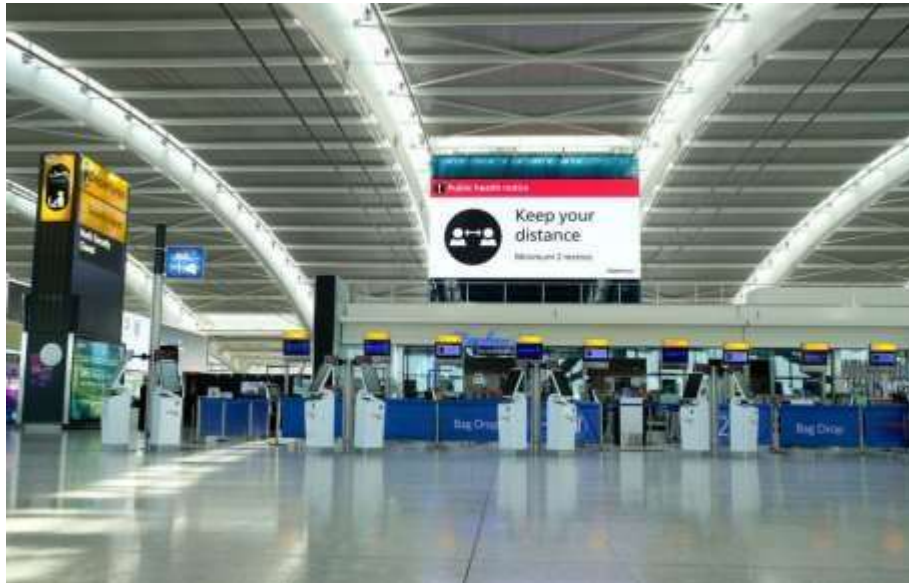

[Image of an airport terminal interior with check-in counters and gates]

□ **Airside:**

- ✓ Area where aircraft operate.

✓ Functions:

- ✚ Runways and taxiways.
- ✚ Aircraft parking aprons.
- ✚ Ground handling operations.
- ✚ Air traffic control.
- Aircraft maintenance.



[Image of an airport airside area with aircraft on runways and taxiways]

c) Arrangement of an Airport Layout:

- Airport layouts vary depending on size, traffic, and terrain.
- Key components:
 - ✓ Runways: Orientated to take advantage of prevailing winds.
 - ✓ Taxiways: Connect runways to aprons and terminals.
 - ✓ Aprons: Parking areas for aircraft.
 - ✓ Terminal buildings: Designed for efficient passenger flow.
 - ✓ Control tower: Provides air traffic control.
 - ✓ Support facilities: Maintenance hangars, fuel storage, etc.



[Image of an airport layout diagram showing runways, taxiways, terminals, and aprons]

d) Modeling a Layout of Airport Physical Components:

- Learners can use materials like:
 - ✓ Cardboard, paper, clay, sticks, etc.
 - ✓ To create a physical model of an airport layout.
- This activity reinforces understanding of airport design and function.

e) Role of an Airport in the Economy:

- Airports are vital for:
 - ✓ Tourism: Facilitating travel for tourists.
 - ✓ Trade: Enabling the transport of goods.
 - ✓ Employment: Creating jobs in various sectors.
 - ✓ Regional development: Stimulating economic growth.
 - ✓ Emergency response: Allowing for quick transportation of aid, and personal.
- Why is an airport important to the aviation industry?

FOR MORE RESOURCES cbckenyahub.com

- ✓ Airports are essential infrastructure that enables air travel and supports the aviation industry.
- Why are there different categories of airports in aviation?
 - ✓ Different categories are needed to accommodate varying levels of air traffic, aircraft sizes, and operational needs.

Aerodrome Excursion:

- ✓ Observe airport operations firsthand.
- ✓ See the different areas of the airport.
- ✓ Learn about the roles of airport staff.
- ✓ Ask questions about airport management.

4.0 Airport Operations 4.2 Airport Business Services

a) Key Business Services in Airport Operations:

□ Landside:

- ✓ **Transportation Services:** Taxis, ride-sharing, car rentals, public transit.
- ✓ **Retail and Dining:** Restaurants, cafes, shops, duty-free stores.
- ✓ **Parking Services:** Short-term and long-term parking.
- ✓ **Hotel Services:** Airport hotels for travelers.
- ✓ **Banking and Currency Exchange:** ATMs, currency exchange counters.

□ Airside:

- ✓ **Ground Handling Services:** Baggage handling, aircraft refueling, ramp services.
- ✓ **Aircraft Maintenance:** Repair and maintenance of aircraft.
- ✓ **Aviation Fuel Services:** Providing fuel for aircraft.
- ✓ **Catering Services:** Providing food and beverages for in-flight meals. ✓ **Cargo Handling:** Loading and unloading cargo.

b) Services Offered by Key Businesses:

- ✓ **Airlines:** Provide passenger and cargo transportation.
- ✓ **Ground Handling Companies:** Offer services like baggage handling, aircraft servicing, and passenger assistance.
- ✓ **Retailers:** Provide shopping and dining options for passengers.
- ✓ **Car Rental Companies:** Offer rental vehicles for travelers.
- ✓ **Fueling Companies:** Provide aviation fuel for aircraft.

FOR MORE RESOURCES cbckenyahub.com

- ✓ **Maintenance, Repair, and Overhaul (MRO) Companies:** Maintain and repair aircraft.
- ✓ **Cargo Companies:** Handle the transportation of goods.

c) Financial Concepts in Aviation Business Services:

- ✓ **Budgeting:** Planning and managing expenses.
- ✓ **Revenue:** Income generated from services.
- ✓ **Expenses:** Costs incurred in providing services.
- ✓ **Profit/Loss:** Difference between revenue and expenses.
- ✓ **Savings:** Setting aside funds for future use.
- ✓ **Investment:** Using funds to generate future income. ✓ **Borrowing:** Obtaining funds from lenders.

d) Rights of Consumers in Airport Operations:

- **Quality:** Right to expect services to be of a satisfactory standard.
- **Information:** Right to accurate and complete information about services.
- **Health:** Right to a safe and healthy environment.
- **Safety:** Right to protection from hazards.
- **Compensation:** Right to receive compensation for losses or damages.

e) Roles of Consumer Protection Agencies:

- ✓ **ICAO (International Civil Aviation Organization):** Sets international standards for aviation safety and security.



- ✓ **IATA (International Air Transport Association):** Represents airlines and promotes safe and efficient air transport.



- ✓ **KCAA (Kenya Civil Aviation Authority):** Regulates and oversees civil aviation in Kenya.



- ✓ **KAA (Kenya Airports Authority):** Manages and operates airports in Kenya.



f) Role of Aviation Businesses in Airport Operations:

FOR MORE RESOURCES cbckenyahub.com

- ✓ Provide essential services that support airport operations.
- ✓ Contribute to the economy by generating revenue and creating jobs.
- ✓ Enhance the passenger experience. ✓ Facilitate trade and tourism.

Aerodrome Excursion:

- ✓ Observe the various businesses operating at the aerodrome.
- ✓ See how these businesses contribute to airport operations.
- ✓ Learn about the roles of different airport personnel.
- ✓ Ask questions about airport business operations.

For more high quality content,